

BALDOR® • RELIANCE 

Product Information Packet

EM2565T-4

250HP,3565RPM,3PH,60HZ,445TS,DP,F1

Part Detail							
Revision:	A	Status:	PRD/A	Change #:		Proprietary:	No
Type:	AC	Elec. Spec:	A44WG1392	CD Diagram:	416820-008	Mfg Plant:	
Mech. Spec:		Layout:	611750-001	Poles:	02	Created Date:	04-24-2015
Base:		Eff. Date:	03-01-2017	Leads:	6#1/0		

Specs			
Catalog Number:	EM2565T-4	Insulation Class:	F
Enclosure:	DP	Inverter Code:	Inverter Ready
Frame:	445TS	IP Rating:	NONE
Frame Material:	Iron	KVA Code:	F
Output @ Frequency:	250.000 HP @ 60 HZ	Lifting Lugs:	Standard Lifting Lugs
Synchronous Speed @ Frequency:	3600 RPM @ 60 HZ	Motor Lead Quantity/Wire Size:	6 @ 1/0 AWG
Voltage @ Frequency:	460.0 V @ 60 HZ	Motor Type:	A44068M
XP Class and Group:	None	Mounting Arrangement:	F1
XP Division:	Not Applicable	Power Factor:	89
Agency Approvals:	CCSA US	Product Family:	General Industrial
	CSA EEV	Pulley End Bearing Type:	Ball
Auxillary Box:	No Auxillary Box	Pulley Face Code:	Standard
Base Indicator:	Rigid	Shaft Ground Indicator:	No Shaft Grounding
Bearing Grease Type:	Polyrex EM (-20F +300F)	Shaft Rotation:	Reversible
Current @ Voltage:	274.000 A @ 460.0 V	Shaft Slinger Indicator:	No Slinger
Design Code:	B	Speed Code:	Single Speed
Drip Cover:	No Drip Cover	Motor Standards:	NEMA
Duty Rating:	CONT	Starting Method:	Wye Start - Delta Run

Feedback Device:	NO FEEDBACK	Thermal Device - Bearing:	None
Heater Indicator:	No Heater	Thermal Device - Winding:	None

Nameplate NP2496L

MOBIL POLYREX EM

Nameplate NP2349L									
SPEC NO.	A44-7177-1392	CAT.NO.	EM2565T-4	FRAME	445TS				
HP	250	VOLTS	460	PHASE	3	DESIGN	B	TYPE	P
RPM	3565	AMPS	274	HZ	60	AMB	40	SF	1.15
DRIVE END BEARING	65BC03J30X	DUTY	CONT	INSUL.CLASS	F				
OPP D.E. BEARING	65BC03J30X	ENCL	DP	CODE	F				
SER.NO.		POWER FACTOR	89	NEMA-NOM-EFFICIENCY	95.4				
				MAX CORR KVAR	30	GUARANTEED EFFICIENCY	94.5		
				NEMA NOM/CSA QUOTED EFF					
				MOTOR WEIGHT	1539				

Parts List		
Part Number	Description	Quantity
SA299617	SA A44-7177-1392	1.000 EA
RA286646	RA A44-7177-1392	1.000 EA
421948044	LABEL, MYLAR	1.000 EA
NP2496L	MOTOR LUBE NAMEPLATE	1.000 EA
000613006PU	N/P (RELEASE QTY 10,000) UL CSA LABEL	1.000 EA
000692000VD	LABEL WARNING	1.000 EA
NP2349L	SUPER-E ,SS, CSA, CSA SUPER-E	1.000 EA
702611001A	BAFFL 440 SUB PAINT	1.000 EA
089438082A	BRKT 440 089438081WCB	1.000 EA
004824015A	GREASE POLYREX EM	0.540 LB
032018028EK	HHCS 5/8-11X3-1/2L PLTD	4.000 EA
032018028CK	HHCS 3/8-16X3-1/2 PLTD.	3.000 EA
410700004F	WSHR	1.000 EA
035000001G	GREASE RELIEF FITTING, ALEMITE 317400	1.000 EA
035000001G	GREASE RELIEF FITTING, ALEMITE 317400	1.000 EA
034017012AB	LCKW 1/4 STD. PLATED 034017012AF	4.000 EA
405851012AB	SPACE	4.000 EA
032018006AK	HHCS 1/4-20X3/4L PLATED	4.000 EA
034000012AB	WSHR 1/4 STD. PLATED	4.000 EA
034600001AA	BUSH 1/4TO1/8 BLACK	1.000 EA
405851012AB	SPACE	4.000 EA
034017012AB	LCKW 1/4 STD. PLATED 034017012AF	4.000 EA
034600001AA	BUSH 1/4TO1/8 BLACK	1.000 EA
034000012AB	WSHR 1/4 STD. PLATED	4.000 EA

Parts List (continued)		
Part Number	Description	Quantity
032018006AK	HHCS 1/4-20X3/4L PLATED	4.000 EA
089438082A	BRKT 440 089438081WCB	1.000 EA
702611001A	BAFFL 440 SUB PAINT	1.000 EA
032018028EK	HHCS 5/8-11X3-1/2L PLTD	4.000 EA
032018028CK	HHCS 3/8-16X3-1/2 PLTD.	3.000 EA
702658001A	CONDUIT BOX, E440	1.000 EA
702658002A	+C/BOX CVR, PAINTED 440	1.000 EA
406056008A	GASKET, TERBD 440	1.000 EA
418153001A	GASK 440	1.000 EA
418150003A	GREASE FITTING CAP	1.000 EA
MG1025Y17	WILKOFAS, 789.701, SUPER E PEARL GOLD	0.438 GA
032018008DK	HHCS 1/2-13X1 PLATED	4.000 EA
048897010DG	PLUG,ODE BRKT - 360	1.000 EA
048977006J	GRFTG - 440	1.000 EA
035000001A	ALFTG 1/8" 1610-BL	1.000 EA
415000103D	T/LUG #4AWG-1/0AWG W/HOLE FOR .250 BOLT	1.000 EA
033512006LB	HHTTS 1/4-20X3/4 PLTD.	8.000 EA
033512004LB	HHTTS 1/4-20X1/2 PLTD.	1.000 EA
035000001A	ALFTG 1/8" 1610-BL	1.000 EA
418150003A	GREASE FITTING CAP	1.000 EA
033775004EA	DRSCR #6-1/4 304 S.S.	2.000 EA
034180024HA	KEY 5/8X5/8X3 L	1.000 EA
604797045	STD. 400 FRAME SKID	1.000 EA
032510024D	CARRIAGE BOLT - 444	2.000 EA

Product Information Packet: EM2565T-4 - 250HP,3565RPM,3PH,60HZ,445TS,DP,F1

034001016AB	WSHR .562ID 1.375OD .109	2.000 EA
034001014AB	FLAT WASHER 3/8"PLATED	2.000 EA
033300014AC	HEX NUT, SHIPPING - 400	2.000 EA
604799003C	PLASTIC BAG 42X32X46	1.000 EA

REL. S.O.	FRAME	HP	TYPE	PHASE/HERTZ	RPM	VOLTS
	445TSC	250	P	3/60	3565	460
AMPS	DUTY	AMB °C/ INSUL.	S.F.	NEMA DESIGN	CODE LETTER	ENCL.
274	CONT	40/F	1.15	B	F	PROT
E/S	ROTOR	TEST S.O.	TEST DATE	STATOR RES. @25 °C (OHMS (BETWEEN LINES))		
498702	418143-14-ME	---	---	.0218		

PERFORMANCE						
LOAD	HP	AMPERES	RPM	POWER FACTOR %	EFFICIENCY %	
NO LOAD	0	70.1	3600	4.36	0	
1/4	62.6	95.0	3592	65.4	94.4	
2/4	125	145	3584	83.8	96.0	
3/4	187	207	3576	88.2	96.1	
4/4	250	274	3567	89.3	95.7	
5/4	312	342	3558	89.8	95.1	

SPEED TORQUE						
	RPM	TORQUE % FULL LOAD	TORQUE LB.-FT.	AMPERES		
LOCKED ROTOR	0	204	751	1752		
PULL UP	1800	181	668	1560		
BREAKDOWN	3427	246	906	1106		
FULL LOAD	3567	100	368	274		

AMPERES SHOWN FOR 460. VOLT CONNECTION. IF OTHER VOLTAGE CONNECTIONS ARE AVAILABLE, THE AMPERES WILL VARY INVERSELY WITH THE RATED VOLTAGE
 REMARKS: TYPICAL DATA

	DR. BY J.J. HARRISON	A-C MOTOR PERFORMANCE DATA
	CK. BY W.I. SMITH	
	APP. BY W.I. SMITH	
DATE 09/24/10	ISSUE DATE 12/18/10	

REL. S. O. _____ RPM 3565 S. F. 1.15 ROTOR 418143-14-ME
 FRAME 445TSC VOLTS 460 NEMA DESIGN B TEST S. O. TYPICAL DATA
 HP 250 AMPS 274 CODE LETTER F TEST DATE ---
 TYPE P DUTY CONT ENCLOSURE PROT STATOR RES. @ 25 °C .0218
 PHASE/HERTZ 3/60 AMB °C/INSUL 40/F E/S 498702 OHMS (BETWEEN LINES)

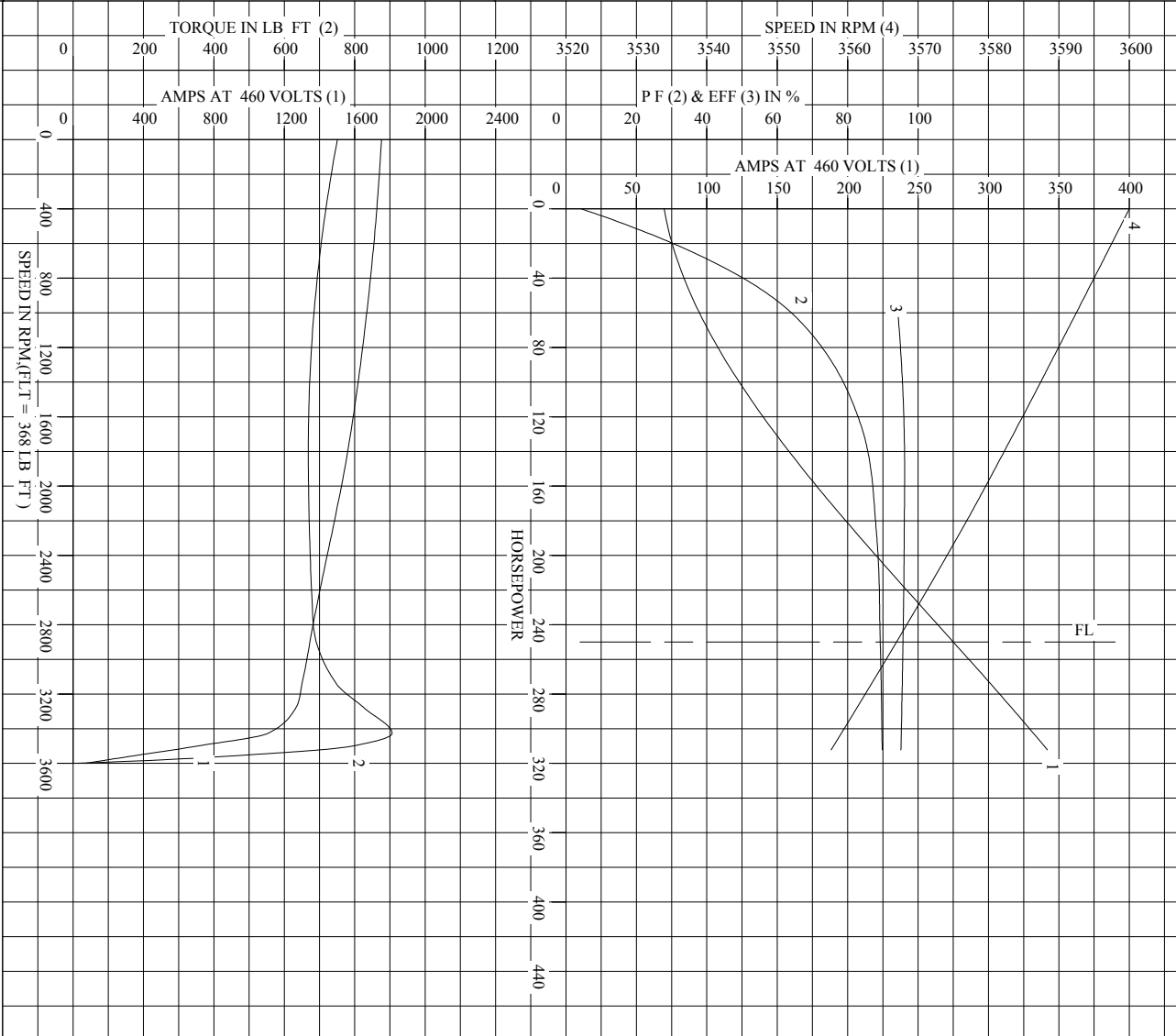

BALDOR

DR. BY J.HARRISON
 CK. BY W.L.SMITH
 App. BY W.L.SMITH
 DATE 09/24/10

A-C MOTOR
PERFORMANCE
CURVES

A44WG1392-R001
 ISSUE DATE 12/18/10

Printed on 12/18/10 1:35 @ psecs-motoreng

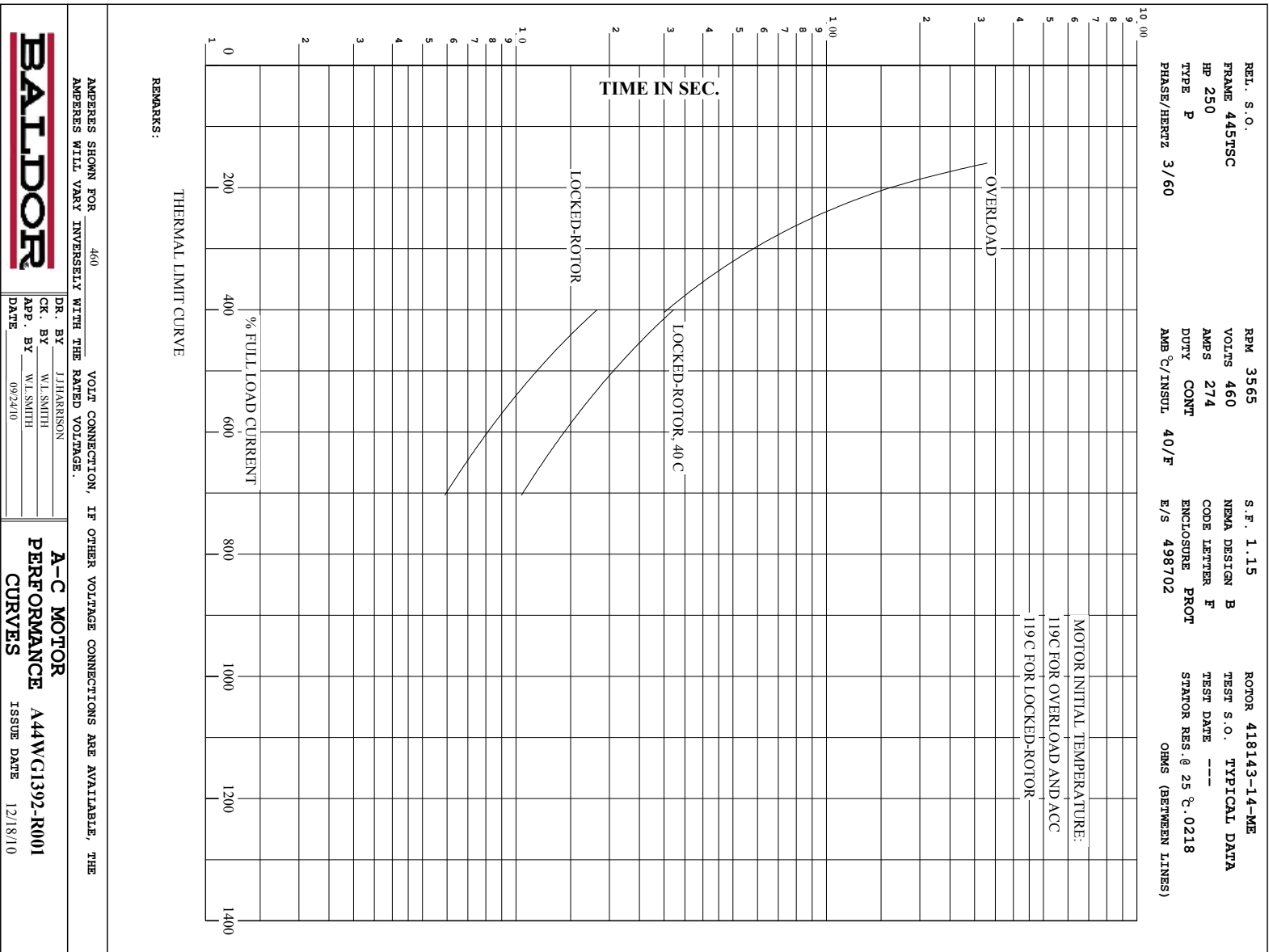

611750-001

DUTY MASTER ALTERNATING CURRENT MOTORS

SQUIRREL-CAGE INDUCTION

ENCLOSURE: PROTECTED
MOUNTING: FOOT

FRAMES 250T THRU 440T

COOLING: SELF-VENTILATED

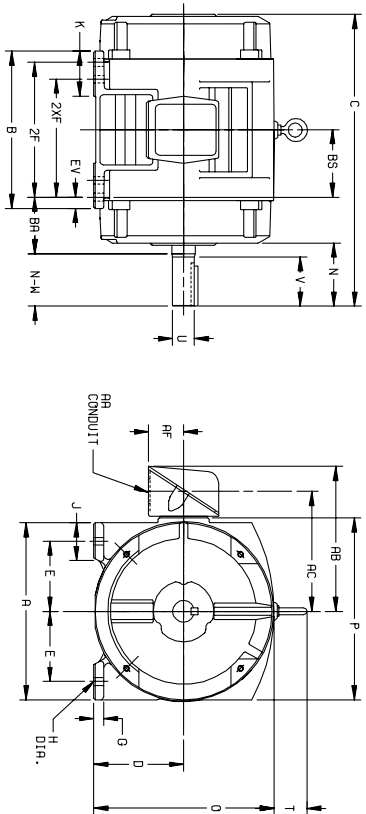

DIMENSIONS ARE IN INCHES

FRAME	A	D(2)	E	G	H	J	K	N	O	P	T	STEEL TERMINAL BOX						WEIGHT LBS. (5)
												AA	AB	AC	AF	BA	EA	
254T-256T	12.50	6.25	5.00	.69	.56	2.25	3.50	12.81	12.69	2.44	1-1/4	10.19	8.19	2.50	4.25	.62		
284T-286T	14.00	7.00	5.50	.75	.56	2.75	3.75	14.12	14.31	2.44	1-1/2	12.19	9.44	3.19	4.75	1.00		
324T-326T	15.75	8.00	6.25	.88	.69	3.12	4.00	16.10	16.42	2.44	2	14.25	10.75	4.25	5.25	1.00		
364T-366T	17.00	9.00	7.00	.88	.69	3.00	3.62	18.30	19.56	2.94	3	18.06	14.00	5.38	5.88	1.00		
404T-406T	19.00	10.00	8.00	1.12	.81	3.25	4.75	20.56	21.81	2.94	3	19.06	15.00	4.38	6.62	1.12		
444T-446T	21.00	11.00	9.00	1.12	.81	3.25	5.25	22.91	23.62	3.25	3	22.62	17.38	5.50	7.50	1.25		

FRAME	SIZE	C	BS	B	ZF	2ZF	N	N-W(6)	SHAFT AND KEY			WEIGHT LBS. (5)
									U(3)	V	SQ.	
254T	22.44	5.00	11.25	---	8.25	4.25	4.00	1.625	3.75	.375	2.75	.265
256T	22.44	5.00	11.25	10.00	---	4.25	4.00	1.625	3.75	.375	2.75	.275
284T	24.94	5.50	13.00	---	9.50	4.88	4.62	1.875	4.38	.500	3.25	.340
286T	23.56	5.50	13.00	---	9.50	3.50	3.25	1.625	3.00	.375	1.88	.370
286T	23.56	5.50	13.00	11.00	---	4.88	4.62	1.875	4.38	.500	3.25	.370
324T	27.56	6.00	14.00	---	10.50	5.50	3.25	1.625	3.00	.375	1.88	.370
324T	27.56	6.00	14.00	12.00	---	4.00	3.75	1.875	3.50	.500	2.00	.465
326T	27.56	6.00	14.00	12.00	---	5.50	3.25	1.625	3.00	.500	2.00	.505
326T	28.06	6.00	14.00	12.00	---	4.00	3.75	1.875	3.50	.500	2.00	.505
364T	29.70	6.12	14.25	---	11.25	6.12	3.88	2.375	3.50	.500	2.00	.710
364T	29.70	6.12	14.25	12.25	---	6.12	3.88	2.375	3.50	.500	2.00	.710
365T	29.70	6.12	14.25	12.25	---	4.00	3.75	1.875	3.50	.500	2.00	.750
365T	29.70	6.12	14.25	12.25	---	6.12	3.88	2.375	3.50	.500	2.00	.750
404T	34.00	6.88	16.00	---	12.25	4.62	4.25	2.125	4.00	.500	2.75	1.020
404T	34.00	6.88	16.00	13.75	---	7.62	4.25	2.125	4.00	.500	2.75	1.060
405T	34.00	6.88	16.00	13.75	---	4.62	4.25	2.125	4.00	.500	2.75	1.060
405T	34.00	6.88	16.00	13.75	---	7.62	4.25	2.125	4.00	.500	2.75	1.060
444T	39.56	8.25	19.00	---	14.50	8.94	4.75	3.375	4.50	.625	3.00	1.750
444T	39.56	8.25	19.00	16.50	---	8.94	4.75	3.375	4.50	.625	3.00	1.750
445T	39.56	8.25	19.00	16.50	---	8.94	4.75	3.375	4.50	.625	3.00	1.750
445T	39.56	8.25	19.00	16.50	---	8.94	4.75	3.375	4.50	.625	3.00	1.750

- (1) SPECIAL DIMENSIONS APPLYING TO THIS ORDER ON THIS LINE.
 - (2) "D" VARIES [290T - 320T +.00, -.03.
 - (3) "U" VARIES +.000, -.001
 - (4) ALL FRAMES HAVE EIGHT MOUNTING HOLES FOR DUAL MOUNTING.
 - (5) MOTOR WEIGHTS MAY VARY BY 15% DEPENDING UPON RATING.
- CONDUIT BOX LOCATED ON OPPOSITE SIDE WHEN F-2-W-1, W-4-W-5-W-7, OR C-1 MOUNTING IS SPECIFIED.

IF MOUNTING CLEARANCE DETAILS ARE REQUIRED, CONSULT FACTORY.

MAXIMUM PERMISSIBLE SHAFT RUNOUT WHEN MEASURED AT END OF STD. SHAFT EXTENSION IS .002 T.I.R. UP TO AND INCLUDING 1.625 DIA. AND .005 T.I.R. ABOVE 1.625 TO 5 INCH DIA.

FRAMES: N-W VARIES +.00, -.25; PE-
 ORDER: ITEM- HP- CERTIFIED FOR- RPM- PH- HZ VOLTS
 SALES ORDER- APPROVED BY- DATE

100-0057119

CUSTOMER IS RESPONSIBLE FOR DETERMINING THAT BALDOR'S PRODUCT WILL PERFORM SUITABLY IN THE INTENDED APPLICATION.

REV. DESC: ASSIGNED TO BUSLOAD	VERSION: 01	TDR: 000000489455
REV. LTR: A	REVISED: 15:03:33 02/02/2009	BY: RAG2JR
FILE: \RAG\00008\297		
MTL: -		

Baldor • Dodge • Reliance

DIM SHT PROT SV FT 250-440T

SH 1 of 1

416820-008

A-C MOTOR CONNECTION DIAGRAM

STANDARD 6 LEAD

Y START - DELTA RUN

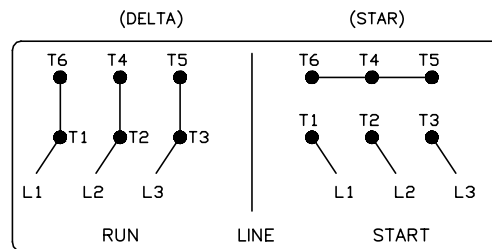
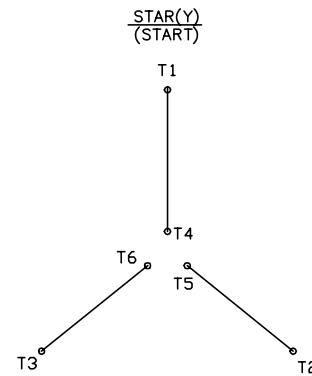
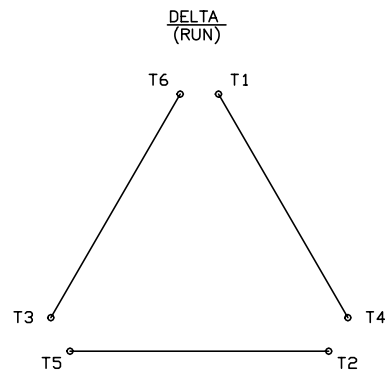

< N. P. 1767-DC >

REV. DESC: ADDED T4 TO Y CONNECT DIAGRAM		
REV. LTR: D	VERSION: 04	TDR: 00000847713
FILE: \RAG\00001\808	REVISED: 10: 41: 26 04/08/2014	BY: RAGJSS1
MTL: -	Ⓢ □	



CONNECT DIAGRAM STD 6 LEAD Y START DELTA RUN

SH 1 of 1

416820-008

Marketing maintained PDF of MN408:

[MN408?ManNumber=MN408](#)

Marketing maintained PDF of MN416:

[MN416?ManNumber=MN416](#)